

KKL2X300

Cable Connectors

- Sales unit = 1 pc
- Suitable for Al/Cu cables
- Material: tin-coated aluminium
- IEC 61238-1 Class A
- Environmentally friendly materials

Conductors per cross section (mm²) table
>>

KKL Installation Instructions >>

Compatibility tables >>

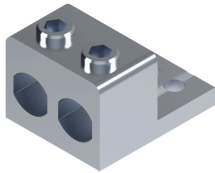
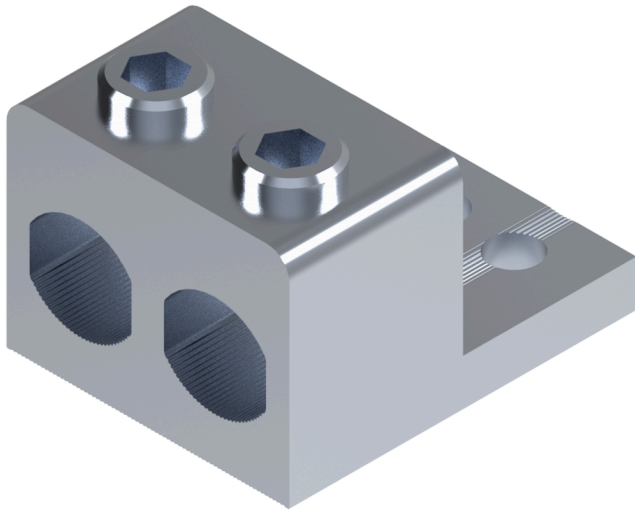

Data subject to change without notice. Always confirm the data is correct from the seller.

Product details

SKU	KKL2X300
Al mm²	95-300
Color	Standard
Cu mm²	95-300
E-Number	1942110
EAN	6419410484296
In (Al) (A)	800
In (Cu) (A)	1040
Key size	Hex 12
Mounting	Bolt M12
Number of Conductors	2
Package size	3
Torque Al/Cu (Nm)	45 (95-120 mm ²) / 75 (150-300 mm ²)
Un (V)	690
Weight (lb/kg)	1.105 / 0.501

Dimensional drawing

